



AM****XMDEH Series

AM****XMDGH Series

AM****XMDEC Series

Air Conditioner installation manual

imagine the possibilities

Thank you for purchasing this Samsung product.

Contents

Safety precautions	3
Outdoor unit type	5
Installation combination	5
Deciding to where to install the outdoor unit	6
Installation location	8
Installation and base ground work for an outdoor unit	10
Refrigerant pipe installation	12
Wiring work	31
Grounding work	36
Setting indoor unit option switch and key function	37
Inspection and check operation	43
Charging refrigerant	46
Pump Down	47
Checking lists after finishing installation	49
Trial operation	50

Safety precautions

Carefully follow the precautions listed below because they are essential to guarantee the safety of the equipment.



WARNING

- Always disconnect the air conditioner from the power supply before servicing it or accessing its internal components.
- Verify that installation and testing operations are performed by qualified personnel.
- Verify that the air conditioner is not installed in an easily accessible area.

General information

- ▶ Carefully read the content of this manual before installing the air conditioner and store the manual in a safe place in order to be able to use it as reference after installation.
- ▶ For maximum safety, installers should always carefully read the following warnings.
- ▶ Store the operation and installation manual in a safe location and remember to hand it over to the new owner if the air conditioner is sold or transferred.
- ▶ This manual explains how to install an indoor unit with a split system with two SAMSUNG units. The use of other types of units with different control systems may damage the units and invalidate the warranty. The manufacturer shall not be responsible for damages arising from the use of non compliant units.
- ▶ The manufacturer shall not be responsible for damage originating from unauthorized changes or the improper connection of electric and requirements set forth in the "Operating limits" table, included in the manual. Making such changes or improper connections may damage the units and invalidate the warranty.
- ▶ The air conditioner should be used only for the applications for which it has been designed: the indoor unit is not suitable to be installed in areas used for laundry.
- ▶ Do not use the units if damaged. If problems occur, switch the unit off and disconnect it from the power supply.
- ▶ In order to prevent electric shocks, fires or injuries, always stop the unit, disable the protection switch and contact SAMSUNG's technical support if the unit produces smoke, if the power cable is hot or damaged or if the unit is very noisy.
- ▶ Always remember to inspect the unit, electric connections, refrigerant tubes and protections regularly. These operations should be performed by qualified personnel only.
- ▶ The unit contains moving parts, which should always be kept out of the reach of children.
- ▶ Do not attempt to repair, move, alter or reinstall the unit. If performed by unauthorized personnel, these operations may cause electric shocks or fires.
- ▶ Do not place containers with liquids or other objects on the unit.
- ▶ All the materials used for the manufacture and packaging of the air conditioner are recyclable.
- ▶ The packing material and exhaust batteries of the remote controller(optional) must be disposed of in accordance with current laws.
- ▶ The air conditioner contains a refrigerant that has to be disposed of as special waste. At the end of its life cycle, the air conditioner must be disposed of in authorized centers or returned to the retailer so that it can be disposed of correctly and safely.
- ▶ This appliance is not intended for use by persons (including children) with reduced physical, sensory or mental capabilities, or lack of experience and knowledge, unless they have been given supervision or instruction concerning use of the appliance by a person responsible for their safety. Children should be supervised to ensure that they do not play with the appliance.
- ▶ When the product operates in heat mode during winter time, it operates protection mode when the outdoor temperature drops below 0°C. Therefore, supply the power during winter time. If the power is not supplied, compressor protection mode will not operate and cause product malfunction.

Safety precautions

Installing the unit



IMPORTANT: When installing the unit, always remember to connect first the refrigerant tubes, then the electrical lines. Always disassemble the electric lines before the refrigerant tubes.

- ▶ Upon receipt, inspect the product to verify that it has not been damaged during transport. If the product appears damaged, **DO NOT INSTALL** it and immediately report the damage to the carrier or retailer (if the installer or the authorized technician has collected the material from the retailer.)
- ▶ After completing the installation, always carry out a functional test and provide the instructions on how to operate the air conditioner to the user.
- ▶ Do not use the air conditioner in environments with hazardous substances or close to equipment that release free flames to avoid the occurrence of fires, explosions or injuries.
- ▶ Our units should be installed in compliance with the spaces shown in the installation manual, to ensure accessibility from both sides and allow repairs or maintenance operations to be carried out. The unit's components should be accessible and easy to disassemble without endangering people and objects.
- ▶ For this reason, when provisions of the installation manual are not complied with, the cost required to access and repair the units (in SAFETY CONDITIONS, as set out in prevailing regulations) with harnesses, ladders, scaffolding or any other elevation system will **NOT** be considered part of the warranty and will be charged to the end customer.

Power supply line, fuse or circuit breaker

- ▶ Always make sure that the power supply is compliant with current safety standards. Always install the air conditioner in compliance with current local safety standards.
- ▶ Always verify that a suitable grounding connection is available.
- ▶ Verify that the voltage and frequency of the power supply comply with the specifications and that the installed power is sufficient to ensure the operation of any other domestic appliance connected to the same electric lines.
- ▶ Always verify that the cut-off and protection switches are suitably dimensioned.
- ▶ Verify that the air conditioner is connected to the power supply in accordance with the instructions provided in the wiring diagram included in the manual.
- ▶ Always verify that electric connections (cable entry, section of leads, protections. . .) are compliant with the electric specifications and with the instructions provided in the wiring scheme. Always verify that all connections comply with the standards applicable to the installation of air conditioners.
- ▶ Devices disconnected from the power supply should be completely disconnected in the condition of overvoltage category.

Outdoor unit type

Shape				
Model	Cooling and Heating	1phase	AM040*XMDEC AM050*XMDEC	AM040*XMDEH AM050*XMDEH AM060*XMDEH
		3phase		AM040*XMDGH AM050*XMDGH AM060*XMDGH

Installation combination

- ▶ You must install the indoor unit that uses R-410A only.
- ▶ If sum capacity of the combined indoor units exceeds the capacity of an outdoor unit, the capacity of each indoor unit is reduced below the rated capacity. Therefore, keeping the combination of indoor units within the capacity of an outdoor unit is recommended.

Outdoor unit	Outdoor unit capacity (HP)	The maximum number of connectable indoor units	Total capacity of the connected indoor units (kW)
AM040*XMD*H Series	4	6	5.6~14.5
AM050*XMD*H Series	5	8	7.0~18.2
AM060*XMD*H Series	6	9	7.8~20.2
AM040*XMD*C Series	4	6	5.6~14.5
AM050*XMD*C Series	5	8	7.0~18.2

Deciding to where to install the outdoor unit

Decide the installation location based on the following condition and obtain the user's approval.

- ▶ Avoid a place that may disturb your neighbor. Noise may occur from the outdoor unit and the discharged air may run into the neighborhood. (Be careful of the operation time in a residential area)
- ▶ Install the outdoor unit on a hard and even area that can support its weight.
- ▶ Choose a flat place where rainwater does not settle or leak.
- ▶ Choose a place that will avoid strong winds.
- ▶ Choose a place that is well ventilated and allows enough space for repairs and service. (Discharge duct can be purchased privately.)
- ▶ Choose a place where the connection of refrigerant pipe between an indoor unit and outdoor unit is within allowed distance.
- ▶ Make sure that the condensed water dripping from the drain hose runs out properly and safely.
- ▶ Choose a place where flammable gas does not leak.
- ▶ Choose a place where the unit could not come into contact with snow and rain.
- ▶ When installing the outdoor unit near sea shore, make sure it is not directly exposed to sea breeze.
 - When installing the outdoor unit near sea shore, consult the qualified installer since the places above require additional measures for corrosion resistance. (You should remove salt and dust of a heat exchanger at least once a year.)

When installing an outdoor unit near sea shore

- ▶ When installing an outdoor unit near sea shore, it should be placed behind a building or surrounded by wind protection wall.
- ▶ Install the outdoor unit in a place where water can drain smoothly.

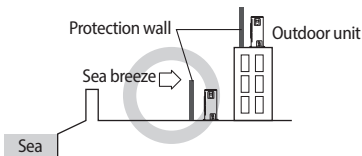
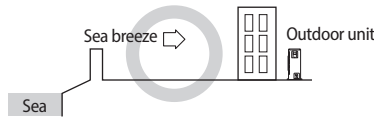
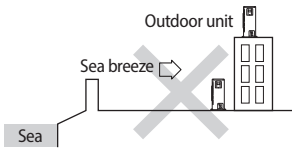

- * Protection wall should be constructed with a solid material such as concrete to block the sea breeze and the height and the width of the wall should be 1.5 times larger than the size of the outdoor unit. (Also, allow over 700mm space between the protection wall and the outdoor unit for ventilation of exhaust air.)



- Install the indoor unit away from any interfering sources such as radio, computer, stereo equipment and also select a place where the electrical wiring work and an indoor unit installation are possible.
 - Especially keep the unit at least 3m away from the electrical equipment in an area where weak electromagnetic waves are generated and install the protection tube to protect the main power cable and communication cable.
 - Make sure that there is no equipment that generates electromagnetic waves. If so, malfunction of the control system may occur due to the effect of the electromagnetic wave. (For example: The remote control sensor of the indoor unit may not have good reception in an area with fluorescent lamp style lighting.)
- Make sure the outdoor unit is installed in a safe place where it will not be obstructed by snowfall. The frame should be installed in a place where the air inlet and heat exchanger of the unit are not buried in the snow.
- A ventilation system may be required when the outdoor unit is installed in a closed space or room, even though R-410a is not poisonous or flammable.
- Install railing around the outdoor unit to prevent it falling when the unit is installed on a high place such as the roof of the building.
- Avoid installing the units in places near an exhaust pipe and ventilating opening exposed to corrosive gas, oxides of sulfur, ammonia gas or sulfur gas herbicides. (These places need additional anticorrosive treatments. Please contact manufacturer to avoid corroding copper pipes or soldered parts.)
- There shouldn't be any inflammable material such as wood and oil around the indoor unit. Otherwise, external fire may spread to the product.
- According to the condition of power supply, electric noise or unstable voltage can occur malfunction of electric parts or control system. (At the ship or places using power supply from electric generator... etc)

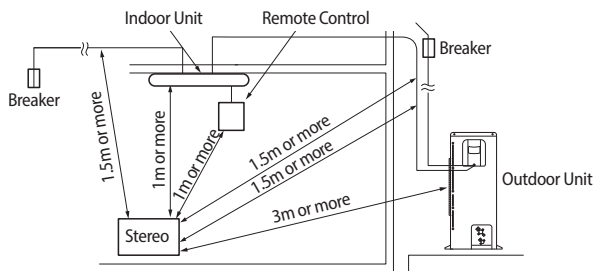

- ▶ Make sure that the water dripping from the drain hose runs away correctly and safely.
- ▶ You should repaint or protect the damaged part so that the paint of the cabinet does not peel off and become rusty during installation. When the cabinet becomes rusty, the life of an outdoor will be reduced.

Installation location

- ▶ Make a space for ventilation and service as seen in the picture.
- ▶ When multiple outdoor units are combined for installation, allow enough space for ventilation against a wall. If the ventilation space is not allowed, product malfunction may occur.
- ▶ The side with logo is the front side of the outdoor unit.

* Figure Description

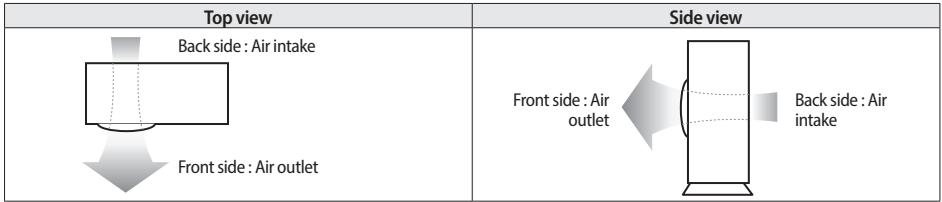

• Air flow direction.

When installing 1 outdoor unit

* When the air outlet is opposite the wall

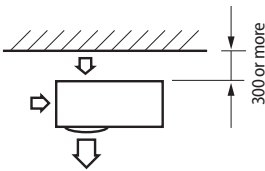

* When the air outlet is toward the wall (Unit : mm)

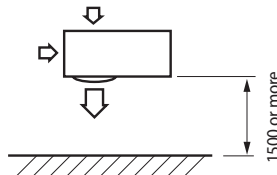

* When 3 sides of the outdoor unit are blocked by the wall

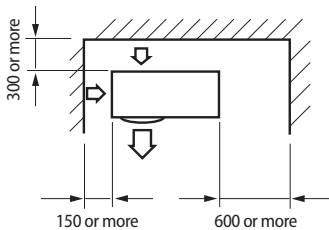

* The upper part of the outdoor unit is blocked and the air outlet is toward the wall

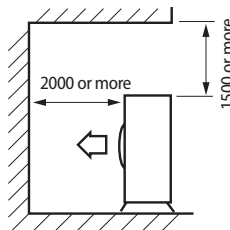

* The upper part of the outdoor unit is blocked and the air outlet is opposite the wall

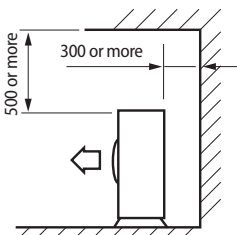

* When the walls are blocking front and the rear of the outdoor unit

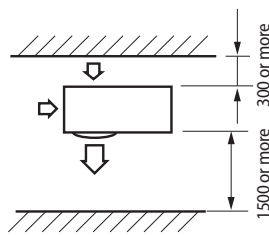

When installing more than 1 outdoor unit

- * When 3 sides of the outdoor unit are blocked by the wall

(Unit : mm)

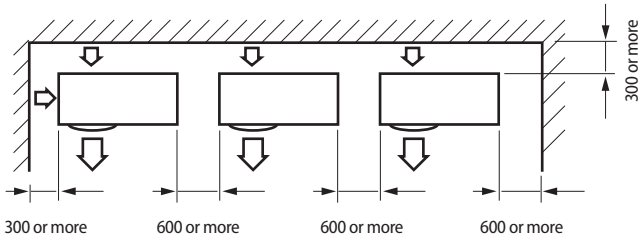

- * When the walls are blocking front and the rear of the outdoor units

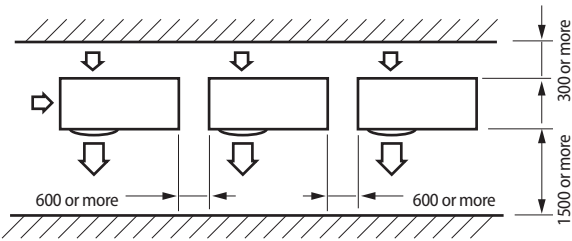

- * When front and rear side of the outdoor unit is toward the wall

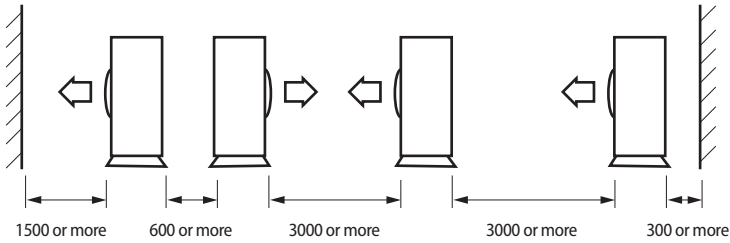

Installation location

Moving the Outdoor Unit

- ▶ Select the moving route in advance.
- ▶ Be sure that moving route is safe from the weight of the outdoor unit.
- ▶ Do not slant the product more than 30° when carrying it. (Do not lay the product down sideways.)
- ▶ The surface of the heat exchanger is sharp. Be careful not to get injured while moving and installing.

When moving with a crane or wire rope

- ▶ When moving an outdoor unit to a higher place such as the rooftop.
 - Fasten the wire rope as seen in the picture.
 - Move the outdoor unit with the product packed to prevent possible product damage during the transportation.

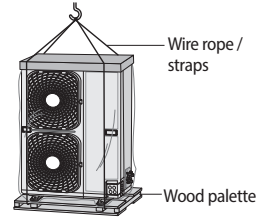

When moving an outdoor unit with hands

- ▶ Moving the outdoor unit by lifting up and carrying due to the short travel distance.
 - Two people should carry the outdoor unit by holding transportation handle.
 - Be careful not to damage the heat exchanger of the rear side of the outdoor unit during transportation.
 - Be careful not to get hurt by the sharp surface of the heat exchanger.

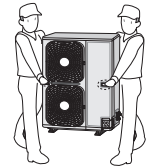

Installation and base ground work for an outdoor unit

- ▶ Install the outdoor unit 150mm higher than the base ground and install the drain hole to connect the pipe to the drainage.
- ▶ When the front fan of an outdoor unit is installed in a place where the average snowfall is more than 150mm, the discharge duct should be attached to the outdoor unit.
- ▶ The concrete foundation should be 1.5 times larger than bottom of the outdoor unit.
- ▶ It is necessary to install wire mesh or steel bar when outdoor units are installed on a soft foundation.
- ▶ When installing multiple outdoor units at the same place, install the H beam on the base ground. (When installing a number of outdoor units, you can install it on the base ground.)
- ▶ Install the H beam(150mm x 150mm x t10 : basic specification) or vibration absorption frame to jut out from the base ground.
- ▶ After installing the H beam, apply corrosion protection.
- ▶ Install a square pad($t=20\text{mm}$ or more) to prevent vibration from the outdoor unit onto the base ground. Place the outdoor unit on the H beam and fix it with the bolt, nut and washer. (Fix with M10 basic anchor bolt, nut and washer.)

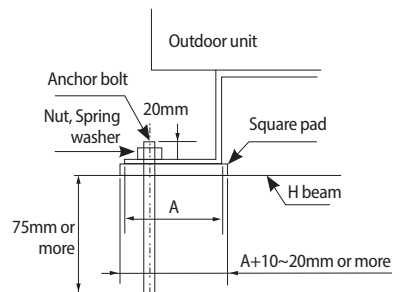

Base ground work

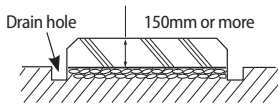

< When installing on the ground >

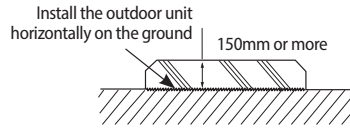

< When installing on the roof >

- ▶ The outdoor unit should be supported within the range of measurement below for base ground work.

(Unit : mm)

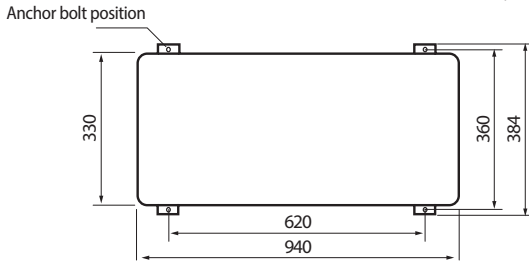

- ▶ When the outdoor unit needs to be supported, fix it with wire as shown in the picture.
 - Slightly unwind the four screws on the cover top of the outdoor unit.
 - Wind wires round the four screws and fasten the screws again.
 - Fix the wires to the ground.

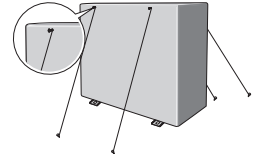

CAUTION

- If the outdoor unit is not fixed securely, product may fall and it might cause loss of life or property damage.
- Do not install the outdoor unit on a wood palette.
- Fix the outdoor unit securely to the base ground with anchor bolts.
- The manufacturer is not responsible for the damage occurred by not adhering to the standard of the installation.
- To protect the outdoor unit from external condition such as rain, install it on the base ground and connect the drain pipe to the drainage.

Refrigerant pipe installation

Refrigerant pipe work

- ▶ The length of refrigerant pipe should be as short as possible and the height difference between an indoor unit and outdoor unit should be minimized.
- ▶ The piping length between the outdoor unit and the indoor unit may not exceed the allowable piping length, height difference, and the allowable length after branching is done.
- ▶ The pressure of the R-410A is high. Use only certified refrigerant pipe and follow the installation method.
- ▶ After pipe installation, charge the refrigerant according to the length of the pipe and R-410A refrigerant should be used.
- ▶ Use clean refrigerant pipe and there shouldn't be any harmful ion, oxide, dust, iron content or moisture inside pipe.
- ▶ Use tools and accessories that fit on R-410A only.



• When installing, make sure there is no leakage. When collecting the refrigerant, stop the compressor first before removing the connection pipe. If the refrigerant pipe is not properly connected and the compressor works with the service valve open, the pipe inhales the air and it makes the pressure inside of the refrigerant cycle abnormally high. It may cause explosion and injury.

Tool	Work		If compatible with conventional tool
Pipe cutter	Refrigerant pipe work	Pipe cutting	Compatible
Flaring tool		Pipe flaring	
Refrigerant oil		Apply refrigerant oil on flared part	Exclusive ether oil, ester oil, alkali benzene oil or synthetic oil
Torque wrench		Connect flare nut with pipe	Compatible
Pipe bender	Pipe bending		
Nitrogen gas	Air tightening test	Inhibition of oxidization	
Brazing tool		Pipe brazing	
Manifold gauge	Air tightening test ~ additional refrigerant charging	Vacuuming, charging and checking operation	Need exclusive one to prevent mixture of R-22 refrigerant oil use and also the measurement is not available due to the high pressure.
Refrigerant charging hose			Need exclusive one due to the refrigerant leakage or inflow of impurities.
Vacuum pump	Vacuum drying		Compatible (Use products which contain the check valve to prevent the oil from flowing backward into the outdoor unit.) Use the one that can be vacuumed up to 100.7kpa(5Torr.-755mmHg).
Scale for refrigerant charging	Charging refrigerant		Compatible
Gas leak detector	Gas leak test		Need exclusive one (The one for R-134a can be used)
Flare nut	You must use the flare nut equipped with product. Refrigerant leakage may occur when the conventional flare nut for R-22 is used.		

Selecting refrigerant pipe

Temper grade and minimum thickness of the refrigerant pipe

Outer diameter [mm]	Minimum thickness [mm]	Temper grade
ø6.35	0.7	Annealed
ø9.52	0.7	
ø12.70	0.8	
ø15.88	1.0	
ø19.05	0.9	Drawn
ø22.23	0.9	



For pipes larger than Ø 19.05, drawn type (C1220T-1/2H or C1220T-H) type copper pipe must be used. If an annealed type (C1220T-O) copper pipe is used, pipe may break due to its low pressure resistance and cause personal injury.

Pipe installation between an outdoor unit and the first Y-joint

Outdoor unit capacity [HP]	Liquid pipe [mm]	Gas pipe [mm]	One step upgraded pipe [mm]
4	ø9.52	ø15.88	ø19.05
5	ø9.52	ø15.88	ø19.05
6	ø9.52	ø19.05	ø22.23

- ▶ Install the refrigerant pipe according to main pipe size of each outdoor unit capacity.
- ▶ When the pipe length between an outdoor unit and the farthest indoor unit including elbow exceeds 90m, the gas pipe size should be upgraded one step among the main pipes from the outdoor unit to the first Y-joint. (The liquid pipe size will be maintained.)
- ▶ If the capacity of the outdoor unit can decline due to the pipe length, upgrade the pipe size one step (gas pipe).

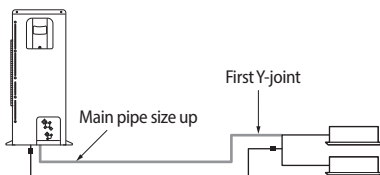

Pipe installation between Y-joints

Indoor unit total capacity(kW)	Pipe diameter (O-D-mm)	
	Liquid pipe (mm)	Gas pipe (mm)
$X \leq 15.0$	ø9.52	ø15.88
$15.0 < X \leq 23.2$		ø19.05

Refrigerant pipe installation

Selecting Y-joint

- ▶ Select the first Y-joint according to main pipe size of each outdoor unit capacity.
- ▶ Select the other Y-joints according to the total indoor unit capacity under the selected Y-joint.

Selecting the first Y-joint	
Outdoor unit capacity (HP)	Y-joint model
4	MXJ-YA1509*
5	MXJ-YA1509*
6	MXJ-YA2512*

Other Y-joints	
Total indoor unit capacity under the selected Y-joint (kW)	Y-joint model
$X \leq 15.0$	MXJ-YA1509*
$15.0 < X \leq 40.6$	MXJ-YA2512*

Keeping refrigerant pipe

To prevent foreign materials or water from entering the pipe, it is important to keep the refrigerant pipe clean and dry and to seal it during installation.

Apply correct sealing method depending on the environment.

Exposure place	Exposure time	Sealing type
Outside exposure	Longer than one month	Pipe pinch
	Shorter than one month	Taping
Inside exposure	-	Taping

Refrigerant pipe brazing and safety information

Important information for refrigerant pipe work

- ▶ Make sure that there is no moisture inside the pipe.
- ▶ Make sure that there are no foreign materials and impurities in the pipe.
- ▶ Make sure that there is no leak.
- ▶ Make sure to follow the instruction when brazing and keeping the pipe.

Nitrogen flushing brazing

- ▶ Use Nitrogen gas when brazing the pipes as shown in the picture.
- ▶ If you do not perform nitrogen flushing when brazing the pipes, oxide may form inside the pipe. It can cause the damage of the important parts such as compressor, valves.
- ▶ Adjust the flow rate of the Nitrogen flushing with a pressure regulator to maintain 0.05m³/h or less.

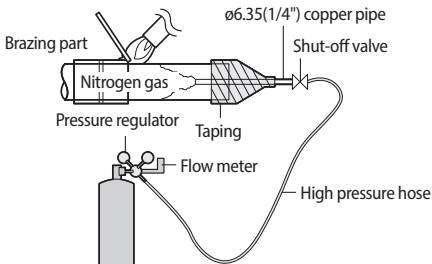

Direction of the pipe when brazing

- ▶ Brazing the pipe should be done with the pipe headed downward or horizontally.
- ▶ Avoid brazing with the pipe headed upward.



The test liquid used to detect leakage after pipe brazing should be the designated one. The use of the test liquid containing sulfur element may cause pipe corrosion.

Cutting or Flaring the pipes

- ▶ Make sure that you prepared the required tools.
 - Pipe cutter, reamer, flaring tool and pipe holder, etc.
- ▶ If you want to shorten the pipe, cut it using a pipe cutter ensuring that the cut edge remains at 90° with the side of the pipe.
 - There are some examples of correctly and incorrectly cut edges below.

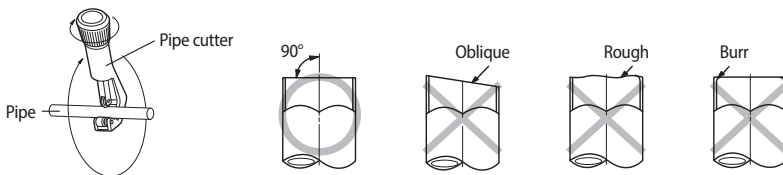

- ▶ To prevent a gas leak, remove all burrs at the cut edge of the pipe using a reamer.
- ▶ Carry out flaring work using flaring tool as shown below.

[Flaring tool]

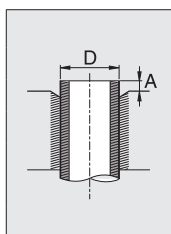
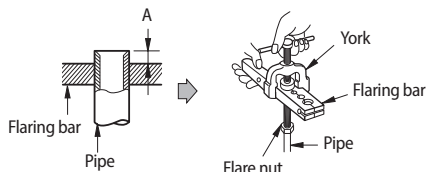

Pipe diameter (mm)	A(mm)		
	Flare tool for R-410A clutch type	Conventional flare tool	
		Clutch type	Wing nut type
ø6.35	0~0.5	1.0~1.5	1.5~2.0
ø9.52	0~0.5	1.0~1.5	1.5~2.0
ø12.70	0~0.5	1.0~1.5	1.5~2.0
ø15.88	0~0.5	1.0~1.5	1.5~2.0

- ▶ Check that you flared the pipe correctly.
 - There are some examples of incorrectly flared pipes below.



If foreign matters or BURRS are not removed after cutting pipe, refrigerant gas may leak.
 If foreign matters enter inside the pipe, the important interior parts of the unit may get damaged or product efficiency will be reduced. So, the direction of pipe should be downward during pipe cutting or flaring.

Refrigerant pipe installation

Tightening flare connection area

- ▶ Check that the flaring is properly made.
- ▶ Align the center of the piping and sufficiently tighten the flare nut with fingers. Finally, tighten the flare nut with torque wrench until the wrench clicks. When tightening the flare nut with torque wrench, ensure the direction for tightening follows the arrow on the wrench.
- ▶ Make sure to use ester oil to coat the flare connection section.

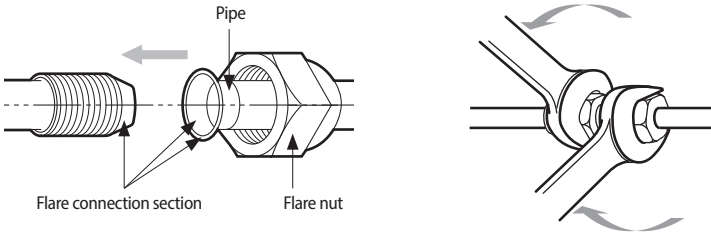

Outer diameter (D)		Torque		Flare dimension (L)		Flare shape (mm)
mm	inch	N·m	lbf·ft	mm	inch	
6.35	1/4	14 ~ 18	10.3 ~ 13.3	8.7 ~ 9.1	0.34 ~ 0.36	
9.52	3/8	34 ~ 42	25.1 ~ 31.0	12.8 ~ 13.2	0.50 ~ 0.52	
12.7	1/2	49 ~ 61	36.1 ~ 45.0	16.2 ~ 16.6	0.64 ~ 0.65	
15.88	5/8	68 ~ 82	50.2 ~ 60.5	19.3 ~ 19.7	0.76 ~ 0.78	

* 1 N·m = 10 kgf·cm



CAUTION

- Blowing Nitrogen gas should be done when brazing the pipe.
- Make sure to use the provided flare nut.
- Make sure that there are no cracks on the bent pipe.
- Do not fasten the flare nut with excessive strength.
- Use ester oil to coat the flare connection area to prevent refrigerant leak. R-410A is a high pressure refrigerant. Therefore, there is a risk of refrigerant leakage if the flare connection is not coated with ester oil.

Pipe installation for an outdoor unit

Pipe direction

The refrigerant pipe can be pulled out from front, flank, rear, and bottom side, so install it depending on the installation site condition.



Caution for using knock-out hole

- Make sure not to damage the exterior of the outdoor unit.
- Remove all burrs at the edge of the knock-out hole and apply the paints it to prevent rust.
- Use a cable tube and bushing to prevent a cable from being damaged when passing through a knock-out hole.
- After installing pipes, block the unused knock hole to prevent small animal from entering. However, the radiant heat hole (A) should be able to intake air.

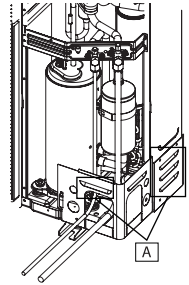

Caution for connecting the pipe

- When brazing the pipe, the unit may get damaged by a brazing fire and a flame. Use a flame proofing cloth to protect the unit from a brazing fire or flame.
- The O-ring and Teflon packing inside service valve may get damaged by a brazing fire. Wrap the bottom side of the service valve with a wet cloth and braze it as shown above. Make sure not to interrupt the brazing with the drips from the wet cloth.
- The connecting pipes of liquid side and gas side should not contact each other nor should they contact to the product. Vibration may cause damage to the pipes.

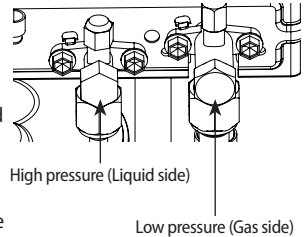

Outdoor unit refrigerant pipe connection

Classification	Front, flank, rear side of pipe connection	Bottom side of pipe connection
Working process	<ul style="list-style-type: none">• First, remove the pipe cover from unit.• Separate the knock-out hole to use. If the hole is open, small animals such as squirrels and rats may get into the unit through the hole and the unit may be damaged.	<ul style="list-style-type: none">• Separate the knock-out hole at the bottom side of the unit and install the pipe.• After installing and insulating the pipe, close up the remaining gap. If the gap remains open, small animals such as rats and squirrels may get inside the unit and cause damage to the unit.

Refrigerant pipe installation

Refrigerant pipe installation examples

Using a Y-joint

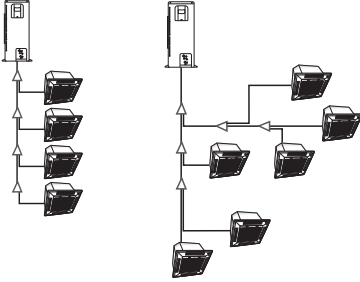

Using a Y-joint/EEV kit

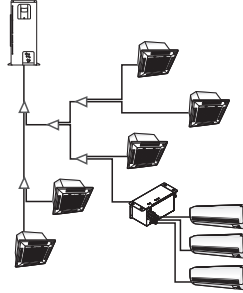

Using a header joint

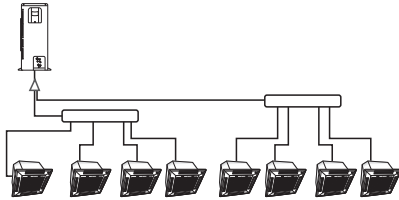

Using a header joint/Y-joint

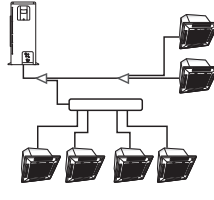

Allowable length of the refrigerant pipe and the installation examples

Connection by Y-joint

Outdoor unit

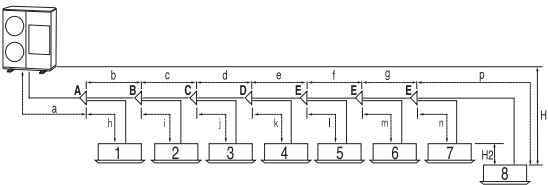

Connection by Y-joint/EEV kit

Outdoor unit

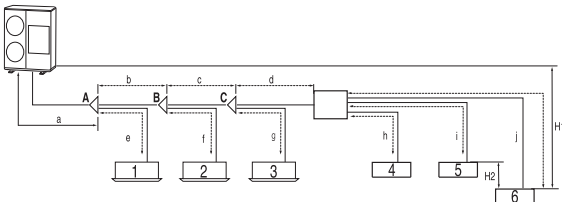

Classification		Y-joint connection	Y-joint / EEV kit connection
Maximum allowable length of pipe	Outdoor unit ~ Indoor units	Actual Length	The distance between the outdoor unit and the farthest indoor unit ≤ 150 m(70 m) Ex) 8 indoor units $a+b+c+d+e+f+g+p \leq 150$ m(70 m)
		Equivalent length	The distance between an outdoor unit and the farthest indoor unit ≤ 175 m(80 m) Ex) 6 indoor units $a+b+c+d+j \leq 150$ m(70 m)
		Main pipe length	The main pipe(a) from the outdoor unit to the first Y-joint should be less than 110 m.
		Total length	The sum of the total length of pipes should be less than 300 m(150 m).
Maximum allowable height	Outdoor unit ~ Indoor units	Height	H1: The difference of height between an outdoor unit and indoor unit < 50 m(30 m)
		Height	H2: The difference of height between indoor units ≤ 15 m
Maximum allowable length after Y-joint		Actual Length	The distance between the first Y-joint and the farthest indoor unit ≤ 40 m Ex) 8 indoor units $b+c+d+e+f+g+p \leq 40$ m
			Allowable length between EEV kit and an indoor unit ≤ 20 m Ex) h, l, j ≤ 20 m

- * When the equivalent length between an outdoor unit and the farthest indoor unit exceeds 90m, upgrade the low pressure pipe of the main pipe one step.
- * Values in () are only applied for AM040*XMDEC and AM050*XMDEC.

Refrigerant pipe installation

Connection by header joint

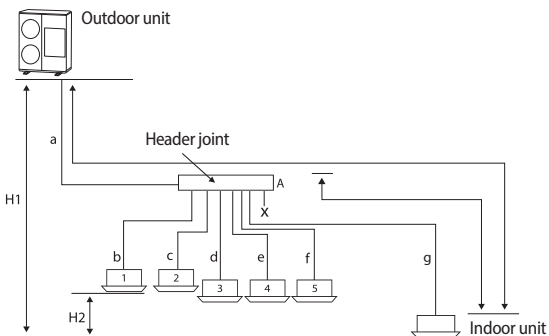

Connection by Y-joint/header joint

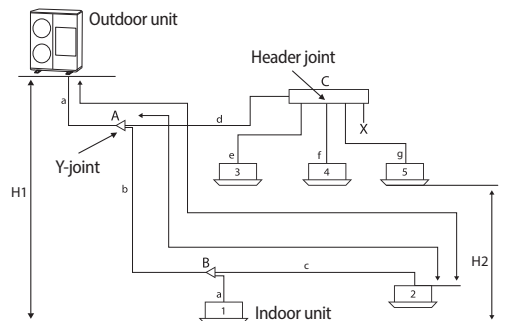

Classification		Header joint connection	Y-joint / header joint connection
Maximum allowable length of pipe	Outdoor unit ~ Indoor units	Actual Length	The distance between an outdoor unit and the farthest indoor unit ≤ 150 m(70 m) Ex) 8 indoor units $a+g \leq 150$ m(70 m)
		Equivalent length	The distance between an outdoor unit and the farthest indoor unit ≤ 175 m(90 m)
		Main pipe length	The main pipe(a) from the outdoor unit to the first Y-joint should be less than 110 m.
		Total length	The sum of total length of pipes should be less than 300 m(150 m).
Maximum allowable height	Outdoor unit ~ Indoor units	Height	H1: The difference in height between an outdoor unit and indoor unit < 50 m(30 m)
		Height	H2: The difference in height between indoor units ≤ 15 m
Maximum allowable length after Y-joint		Actual Length	The distance between the header joint and the indoor unit ≤ 40 m Ex) b, c ~ f, g ≤ 40 m
			The distance between the first Y-joint and the farthest indoor unit ≤ 40 m Ex) 8 indoor units b+c, d+g ≤ 40 m

* When the equivalent length between an outdoor unit and the farthest indoor unit exceeds 90m, upgrade the low pressure pipe of the main pipe one step.

* Values in () are only applied for AM040*XMDEC and AM050*XMDEC.

Refrigerant pipe work

Refrigerant Y-joint installation

Install the Y-joint 'horizontally' or 'vertically'.

► Install horizontally

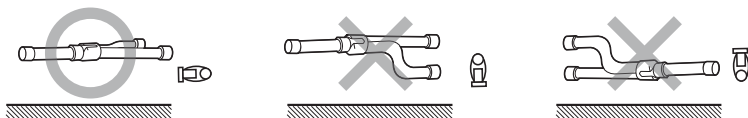

► Install vertically

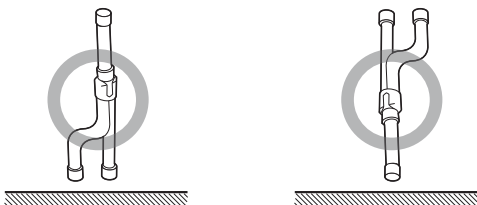

NOTE

- When using A~J type of Y-joint, connect the Y-joint to the pipe with the provided reducer.
- When using K~Z type of Y-joint, connect the Y-joint to the pipe by cutting the inlet of the Y-joint or provided reducer properly.



CAUTION

- Install the Y-joint within $\pm 15^\circ$ on the horizontal or on the vertical.
- Make sure that the pipe does not break at Y-joint and pipe connection.
- Keep a minimum straight line distance of 500mm or more before connecting Y-joint.

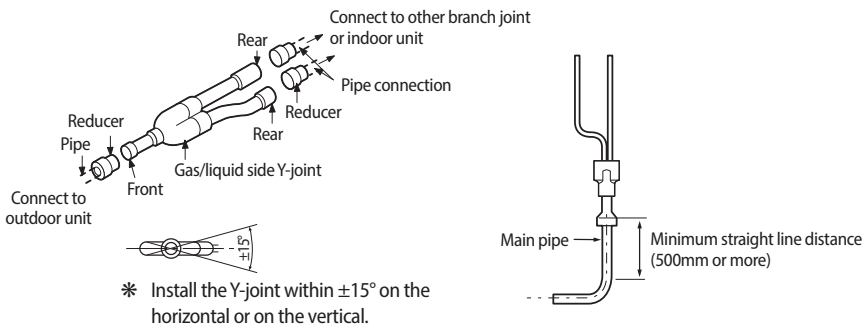

Refrigerant pipe installation

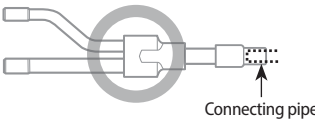
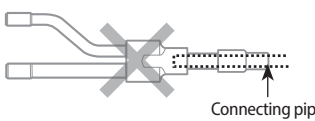
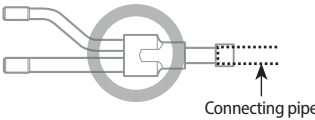
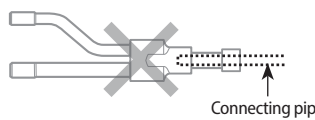
	Correct use (The insertion depth of connecting pipe)	Incorrect use (The insertion depth of connecting pipe)
Basic specification		
When cutting connection part		



• When inserting connecting pipe into the Y-joint, please comply with the installation regulation.

Refrigerant header joint installation

- ▶ Select the reducer fitted on the diameter of the pipe.

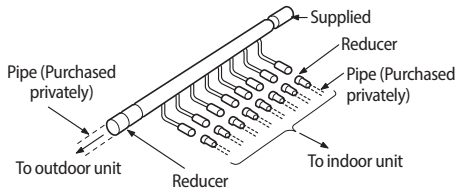
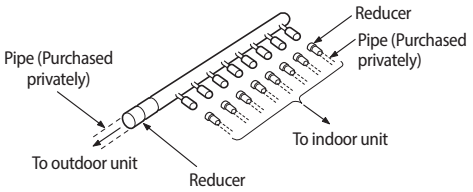
Liquid side	Gas side
	

- ▶ Block the unused pipes end with caps if the number of connected indoor unit is fewer than header joint ports.

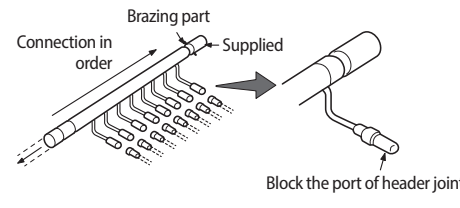
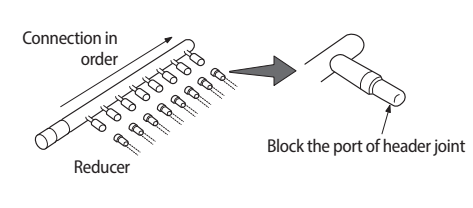
Liquid side	Gas side
	



- When using A~J type of header joint, connect the header joint to the pipe with provided reducer.
- When using K~Z type of header joint, connect the header joint to the pipe by cutting the provided reducer properly.
- Connect the header joint in order respecting the number of the indoor unit.
- Connect the indoor unit as the highest capacity comes first.

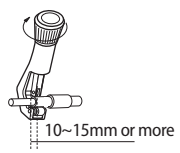
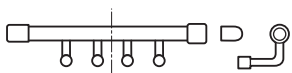

- ▶ Install the header joint horizontally.
 - Install the header joint horizontally so that it is not facing down.

<p>Liquid side</p>	
<p>Gas side</p>	

Refrigerant pipe installation

Performing air tightening test

- ▶ Use tools for R-410A only to prevent the inflow of foreign substances and to resist the internal pressure.
- ▶ Use dry Nitrogen gas to do an airtight test as below.

Apply pressure to the liquid side pipe, gas side pipe with Nitrogen gas of 4.1MPa (gauge pressure).

If you apply pressure more than 4.1MPa (gauge pressure), the pipes may be damaged. Apply pressure using pressure regulator.

Continue to apply pressure for minimum 24 hours to check if the pressure drops.

After applying Nitrogen gas, check the change of pressure using pressure regulator.

If the pressure drops, check if there is a gas leak.

If the pressure is changed, apply soapy water to check the leak. Check the pressure of the gas again.

Maintain 1.0 MPa (gauge pressure) of the pressure before performing vacuum drying and check for further gas leak.

After checking first gas leak, maintain 1.0 MPa (gauge pressure) to check for further gas leaks.

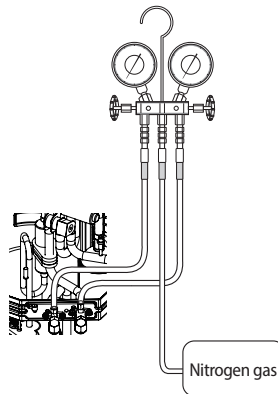

- If the joint of high pressure side is disconnected and the nitrogen gas come into contact with human body, injury may occur. Tighten the joint connection firmly to prevent dangerous situation.

Vacuumping a pipe and an indoor unit

- ▶ Use the tools for R-410A only to prevent the inflow of foreign substances and resist against the internal pressure.
- ▶ Use the vacuum pump with the check valve to prevent pump oil from flowing backward while the vacuum pump is stopped suddenly.
- ▶ Use the vacuum pump that can be vacuumed up to 666.6Pa(5mmHg).
- ▶ Close the service valve of the liquid side pipe, gas side pipe completely when performing air tightening test or vacuum drying.

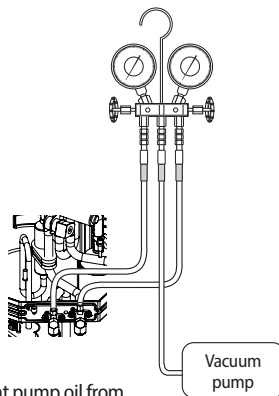

Connect the manifold gauge to the liquid pipe and gas pipe.

Vacuum the liquid pipe and gas pipe using the vacuum pump.

Make sure to install check valve to prevent pump oil from flowing into the pipe.

Vacuum those pipes for more than 2 hours and 30 minutes.

The time of vacuum drying may differ depending on the length of the pipe or outdoor temperature.
Perform vacuum drying for at least 2 hours and 30 minutes.

Close the valve after checking the vacuum gauge pressure has reached at -100.7 kPa (gauge pressure).

Check the vacuum pressure using the vacuum gauge.

Check whether the pressure is maintained as -100.7 kPa (gauge pressure), 5 torr. for an hour.

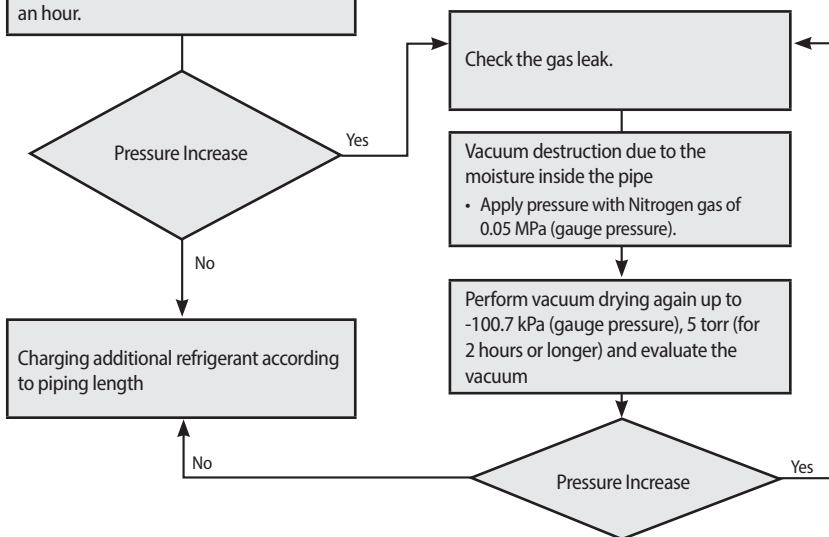

• If the pressure rises in an hour, either water remains inside the pipe, or there will be a leak.

Refrigerant pipe installation

Selecting additional refrigerant charging

► Basic refrigerant

The basic amount of additional refrigerant charged at a factory

Model	Refrigerant	Factory charge(kg)
AM040*XMDEH	R-410A	3.2
AM050*XMDEH		3.2
AM060*XMDEH		3.3
AM040*XMDGH		3.2
AM050*XMDGH		3.2
AM060*XMDGH		3.3
AM040*XMDEC		2.0
AM050*XMDEC		2.0

► Charging additional refrigerant

The amount of additional refrigerant charging = The amount of refrigerant charging for pipe + the amount of refrigerant correction charging for an indoor unit.
--

1. The amount of additional refrigerant depending on the pipe size.

- Amount of additional refrigerant has to be calculated based on the sum of all liquid pipe length.

Size of liquid pipe (mm)	6,35	9,52	12,7	15,88
Additional amount (kg/m)	0,02	0,06	0,125	0,18

Additional refrigerant charging calculation = The sum of total length of Ø 9.52 liquid pipe(m) x 60g + the sum of total length of Ø 6.35 liquid pipe(m) x 20g

Ex) a(Ø 9.52)=40m, b+c+d(Ø 9.52)=15m, e+f+g(Ø 6.35)=15m

The amount of additional refrigerant = 55m x 60g + 15m x 20g = 3600g

2. The amount of additional refrigerant for each indoor unit

(Unit : kg)

Model \ Capacity (kW)	2.2	2.8	3.6	4.5	5.6	6.0	7.1	8.2	9.0	11.2	12.8	14.0
Slim 1way cassette (JSF) (AM***FN1DEH*)			0.25		0.32		0.32					
2way cassette (AM***FN2DEH*)					0.31		0.31					
Global 4way cassette (AM***FN4DEH*)				0.45	0.45		0.45		0.45	0.57	0.69	0.69
360 cassette (AM***KN4DEH*)					0.45		0.45		0.45	0.69	0.69	0.69
Global mini 4way cassette (AM***FNNDHEH*)	0.29	0.29	0.29	0.37	0.37	0.37						
Slim duct (AM***FNLDEH*)	0.24	0.24	0.24	0.24	0.45		0.45					
MSP duct (AM***FNMDEH*)					0.28		0.28		0.32	0.54	0.68	0.68
AR5000 (AM***028JNVDKH)	0.22	0.25	0.34	0.34	0.71		0.71	0.71				
Boracay (AM***KNQDEH*)	0.24	0.32	0.32	0.49	0.49		0.49					

Ex) When the indoor unit AM036FN1DEH* and AM056FN4DEH* are combined

Additional refrigerant charging = 250g + 450g = 700g

3. The total amount of additional refrigerant charging = the amount of refrigerant charging for pipe + the amount of refrigerant for each indoor unit.

Ex) The amount of additional refrigerant charging = 3600g + 700g = 4300g

Connecting the drain hose to the outdoor unit

When using the air conditioner in the heating mode, ice may accumulate. During de-icing (defrost operation), the condensed water must be drained off safely. Consequently, you must install a drain hose on the outdoor unit, following the instructions below.

- ▶ Leave space of more than 50mm between the bottom of the outdoor unit and the ground for installation of the drain hose, as shown in figure.
- ▶ Insert the drain plug into the hole on the underside of the outdoor unit.
- ▶ Connect the drain hose to the drain plug.
- ▶ Ensure that the drained water runs off correctly and safely.

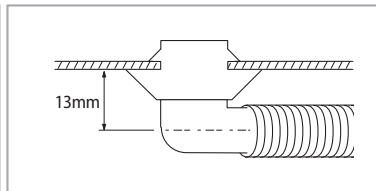
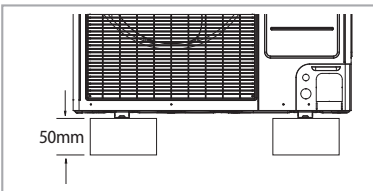

- ▶ Be sure to plug the rest of drain holes not connected with drain plugs using drain caps.

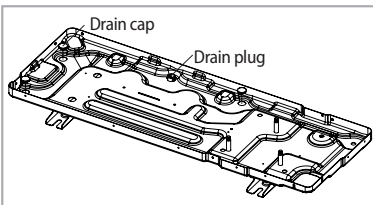

Refrigerant pipe installation

Insulating refrigerant pipe or Y-joint

- ▶ You must check if there is a gas leak before completing all the installation process. After you check that the gas does not leak, you must insulate the pipe and hose.
- ▶ Use EPDM insulation which meets the following condition.

Item	Unit	Standard
Density	g/cm ³	0.048~0.096
Dimension change route by heat	%	-5 or less
Water absorption rate	g/cm ³	0.005 or less
Thermal conductivity	kcal/m·h·°C	0.032 or less
Moisture transpiration factor	ng/(m ² ·s·Pa)	15 or less
Moisture transpiration grade	g/(m ² ·24h)	15 or less
Formaldehyde dispersion	mg/L	-
Oxygen rate	%	25 or more

Selecting the insulation of refrigerant pipe

- ▶ Insulate the gas pipe and liquid pipe by referring to the thickness of insulator for each pipe size.
- ▶ The standard condition is 30°C, with humidity less than 85%. In the conditions of high humidity, use one grade thicker.

Pipe	Pipe size (mm)	Insulation(Cooling, Heating)		Remarks
		Standard [30°C, 85%]	High humidity [30 °C, 85% or more]	
		EPDM, NBR		
Liquid pipe	Ø6.35~Ø9.52	9t	←	Heat resisting temperature is more than 120°C
	Ø12.70~Ø50.80	13t	←	
Gas pipe	Ø6.35	13t	19t	
	Ø9.52	19t	25t	
	Ø12.70			
	Ø15.88			
	Ø19.05			
Ø22.23				

Insulating refrigerant pipe

- ▶ You must insulate refrigerant pipe, Y-joint, header joint, and pipe connection area.
- ▶ If you insulate the pipes, the condensed water does not fall from the pipes.
- ▶ Check if there are any insulation cracks on the bent pipe.

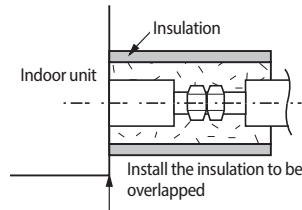
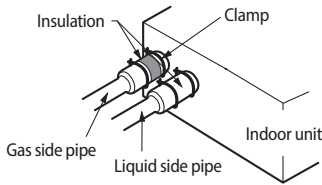

Fix securely without any gap.

Pipe insulation	Pipe insulation after insulating EEV kit
<ul style="list-style-type: none"> • The insulation of the gas and liquid pipes can be in contact with each other but they should not press excessively against each other. • When contacting the gas side and liquid side pipe, use thicker insulation. 	<ul style="list-style-type: none"> • When installing the gas side and liquid side pipes, leave 10mm of space. • When contacting the gas side and liquid side pipe, use thicker insulation.



- Install the insulation not to get wider and use adhesive on the connection part of it to prevent moisture entering.
- Bind the refrigerant pipe with insulation tape if it is exposed to outside sunlight. (When binding the pipe with finishing tape, be careful not to reduce the thickness of the insulation.)
- Install the refrigerant pipe respecting that the insulation does not get thinner on the bent part or hanger of pipe.
- When the thickness of insulation is reduced, supplement the reduced thickness with additional insulation.

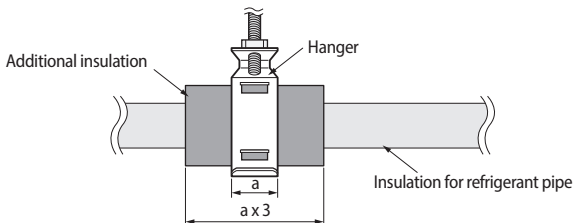

Refrigerant pipe installation

Insulating the header joint

- ▶ Fasten the header joint using a cable tie and cover the connected part.
- ▶ Insulate the header joint and the brazing part and wrap the connected part with an adhesive insulation tape to prevent dew formation.

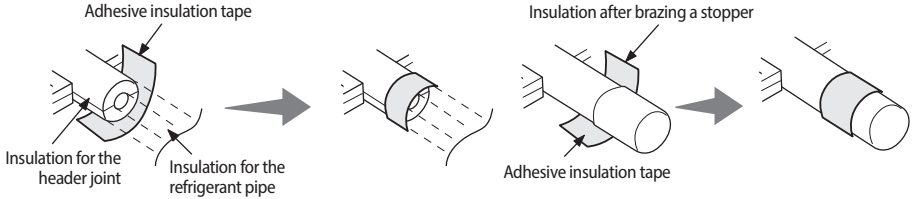
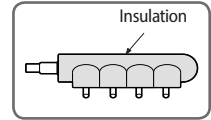

- ▶ Fix the header joint with a hanger after insulating it.

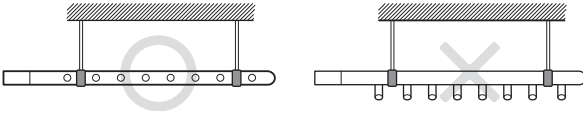

Insulating the Y-joint, liquid & gas side connecting pipe

- ▶ Attach the insulation provided with the Y-joint to the insulation purchased privately without a gap. Wrap the connected part with insulation (Purchased privately) of a thickness of at least 10mm.
- ▶ Use insulation that should be able to handle an interior temperature of over 120°C. Wrap the Y-joint with insulation of a thickness of at least 10mm.

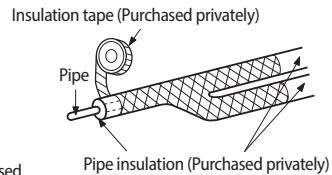
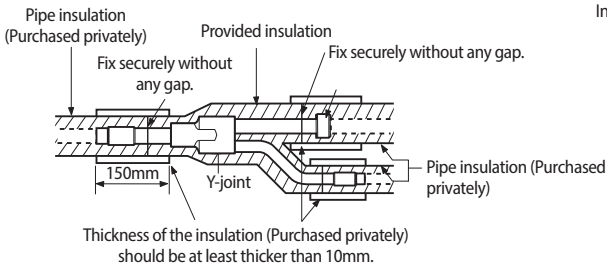

- * Attach the adhesive insulation tape to the pipe as shown in the picture after insulating the pipe.

Wiring work

- ▶ Wiring work should be performed in accordance with related laws such as 'Technical specification on electric installation', 'Wiring regulations' or 'Installation manual'.
- ▶ Copper cable should be used for wiring work and all the wires or parts should be rated products.
- ▶ Wiring work should be performed by a company certified by an electric power company.
- ▶ Refer to the circuit diagram attached to the outdoor unit for detailed wiring work.
- ▶ Wiring work should be performed after disconnecting main circuit breaker and Y-joint switch.
- ▶ You must perform grounding work .
(Grounding resistance value should be less than 100Ω.)
When ELCB is installed, protective grounding resistance value can be applied.
(When the ELCB is 100mA, 0.1sec, protective grounding resistance value should be less than 250Ω at a place where electric danger is high and should be less than 500Ω at other places.)
- ▶ Electric wiring circuit diagram displays outline only.
- ▶ Do not connect a heater to an outdoor unit and do not install a duct which you arbitrarily remodeled.
 - Failure to do so may result in reduced capacity of an air conditioner, electric shock, and fire.
- ▶ Do not connect the grounding wire to that of gas pipe, water pipe, lightning rod, or telephone.
 - Gas pipe: If the gas leaks, explosion or ignition may occur.
 - Water pipe: If rigid vinyl pipe is used, grounding effect will not work.
 - Grounding wire and lightning rod of telephone: The electric potential of grounding wire may rise abnormally in the falling of a thunderbolt.
- ▶ The ELB for ground-fault protection only should be combined with MCCB or fuse equipped load breaker switch. In this case, you should use the one that has at least the same or more capacity as fuse capacity or the rated current of MCCB.
- ▶ Use the wires that comply with regulated specification and firmly connect to the terminal board. Then tighten it with the screws provided so that the terminal board cannot be moved by external force. (The connecting cable and the grounding terminal should be locally procured). When wiring, the connection cable shouldn't be too tight.
- ▶ Apply silicon at the end of CD pipe so that rainwater does not enter.

Conduit leading into an outdoor unit

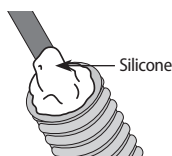

Wiring work

Overall System Configuration

Connection of the power cable (1 phase 2 wires)

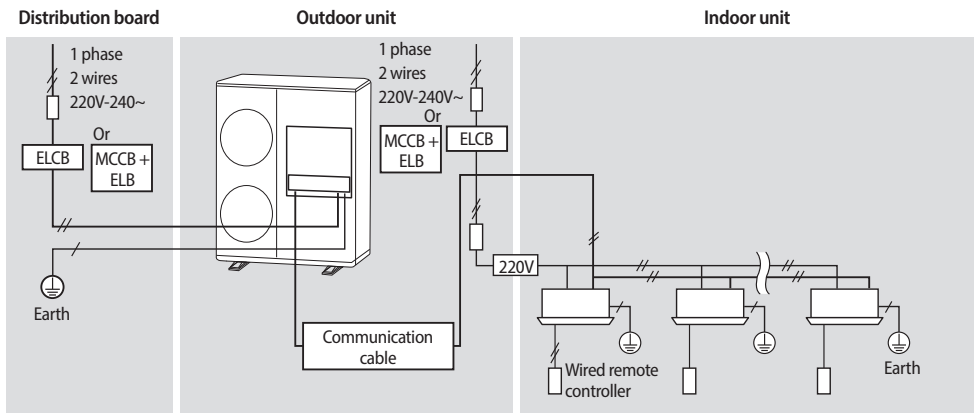

Connection of the power cable (3 phase 4 wires)

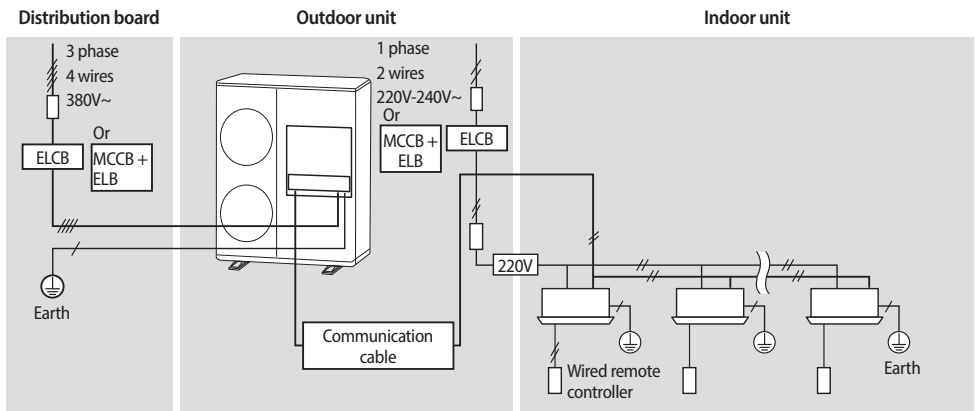

- You must install an earth leakage breaker.
 - ELCB(Earth Leakage Circuit Breaker)
 - MCCB(Molded Case Circuit Breaker)
 - ELB(Earth Leakage fuse breaker)
- Manufacturers are not responsible for fire caused by not installing ELCB or MCCB.
- Install the cabinet panel near the outdoor unit for service convenience and emergency operation switch off.
- You must install a circuit breaker that can prevent excess current and shut off the electric leakage on the outdoor unit.

Specification for circuit breaker and power supply cord

- ▶ Power supply cord is not supplied with air conditioner.
- ▶ Select the power supply cord in accordance with relevant local and national regulations.
- ▶ Wire size must comply with the applicable local and national code.
- ▶ The appliance shall be provided with a certified power supply cord and interconnection cord complying with the national regulations of the countries in which the appliance is to be sold.
- ▶ Power supply cords of parts of appliances for outdoor use shall not be lighter than polychloroprene sheathed flexible cord. (Code designation IEC : 60245 IEC 57 / CENELEC : H05RN-F)

Model	Voltage	MCA	MFA	S _{sc} value (MVA)
AM040*XMDEH	1 phase, 220~240V/50Hz	22	32	(Note1)
AM050*XMDEH		24	32	(Note1)
AM060*XMDEH		32	40	(Note1)
AM040*XMDEC		24	32	(Note1)
AM050*XMDEC		24	32	(Note1)

(Note1) Equipment complying with IEC 61000-3-12.

Model	Voltage	MCA	MFA	S _{sc} value (MVA) ^(Note2)
AM040*XMDGH	3phase, 380~415V/50Hz	10	16.1	3.3
AM050*XMDGH		12	16.1	3.3
AM060*XMDGH		12	16.1	3.3

(Note2) This equipment complies with IEC 61000-3-12 provided that the short-circuit power S_{sc} is greater than or equal to S_{sc} value at the interface point between the user's supply and the public system. It is the responsibility of the installer or user of the equipment to ensure, by consultation with distribution network operator if necessary, that the equipment is connected only to a supply with a short-circuit power S_{sc} greater than or equal to S_{sc} value.

Tightening power terminal

- ▶ Connect the cables to the terminal board using the compressed ring terminal.
- ▶ Use rated cables only.
- ▶ Connect the cables with driver and wrench that can apply the rated torque to the screws.
- ▶ Make sure that appropriate tightening torque is applied for cable connection. If the terminal is loose, arc heat may occur and cause fire and if the terminal is connected too firmly, terminal may get damaged.

Tightening torque (kgf·cm)		
M4	12.0~18.0	Communication : F1, F2 3 phase AC power : 1(L), 2(N), L, N, L1(R), L2(S), L3(T), N
M5	20.0~30.0	1 phase AC power : 1(L), 2(N), L, N

Wiring work

Selecting compressed ring terminal

- ▶ Select a compressed ring terminal of a connecting power cable based on a nominal dimensions for cable.
- ▶ Cover a compressed ring terminal and a connector part of the power cable and then connect it.

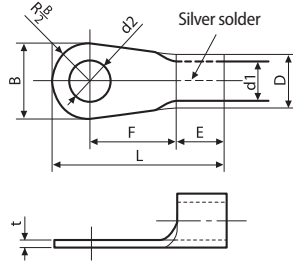
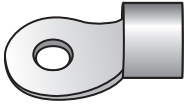

Nominal dimensions for cable (mm ²)		4/6		10	16	25		35		50	70
Nominal dimensions for screw (mm)		4	8	8	8	8	8	8	8	8	8
B	Standard dimension (mm)	9.5	15	15	16	12	16.5	16	22	22	24
	Allowance (mm)	±0.2		±0.2	±0.2	±0.3		±0.3		±0.3	±0.4
D	Standard dimension (mm)	5.6	7.1	9	11.5	13.3		13.5	17.5		
	Allowance (mm)	+0.3 -0.2	+0.3 -0.2	+0.3 -0.2	+0.5 -0.2	+0.5 -0.2		+0.5 -0.2	+0.5 -0.4		
d1	Standard dimension (mm)	3.4	4.5	5.8	7.7	9.4		11.4	13.3		
	Allowance (mm)	±0.2		±0.2	±0.2	±0.2		±0.3	±0.4		
E	Min.	6		7.9	9.5	11		12.5	17.5	18.5	
F	Min.	5	9	9	13	15	13	13		14	20
L	Max.	20	28.5	30	33	34		38	43	50	51
d2	Standard dimension (mm)	4.3	8.4	8.4	8.4	8.4		8.4	8.4	8.4	8.4
	Allowance (mm)	+0.2 0	+0.4 0	+0.4 0	+0.4 0	+0.4 0		+0.4 0	+0.4 0	+0.4 0	+0.4 0
t	Min.	0.9		1.15	1.45	1.7		1.8	1.8	2.0	

Installing grounding wire

- ▶ Grounding must be done by a qualified installer for your safety.
- ▶ Use the grounding wire by referring to the specification of the electric cable of the outdoor unit.

Grounding the power cable

- ▶ The standard of grounding may vary according to the rated voltage and installation place of the air conditioner.
- ▶ Ground the power cable according to the following.

Installation place Power condition	High humidity	Average humidity	Low humidity
Voltage of lower than 150V		Perform the grounding work 3. <small>Note 1)</small>	Perform the grounding work 3 if possible for your safety. <small>Note 2)</small>
Voltage of higher than 150V		Must perform the grounding work 3. <small>Note 1)</small> (In case of installing circuit breaker as well)	



1. Grounding work 3

NOTE

- Grounding must be done by your installation specialist.
- Check if the grounding resistance is lower than 100Ω. When installing a circuit breaker that can cut the electric circuit within 0.5 second in case of a short circuit, the allowable grounding resistance should be 30~500Ω.

2. Grounding at dry place

- The grounding resistance is should be lower than 100Ω. (It should not be higher than 250Ω)
 - Use the rated grounding wire by referring to the specification of the electric cable of the outdoor unit.

Performing the grounding work

- ▶ Use the grounding wire by referring to the specification of the electric cable for the outdoor unit.

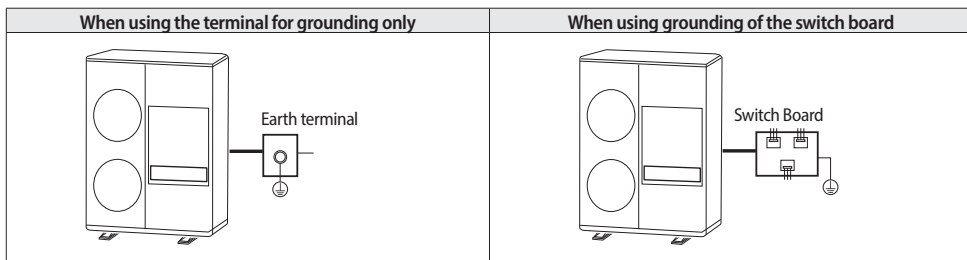

Grounding work

If the power distribution circuit does not have a grounding or the grounding does not comply with specifications, a ground rod must be installed.

The corresponding accessories are not supplied with the air conditioner.

1. Select a grounding rod that complies with the specifications given in the illustration.

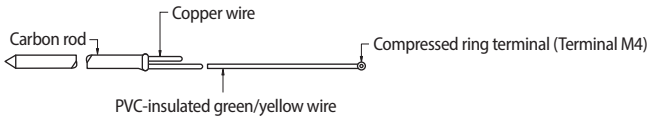

2. Select a proper place for the grounding rod installation.

- In damp hard soil rather than loose sandy or gravel soil that has a higher grounding resistance.
- Away from underground structures or facilities, such as gas pipes, water pipes, telephone lines and underground cables.
- At least two meters away from lightning(as in a storm) conductor.

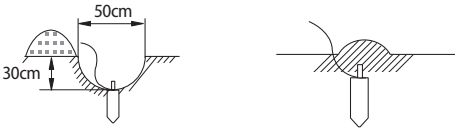

- The grounding wire for the telephone line cannot be used to ground the air conditioner.

3. Install a green/yellow coloured grounding wire :

- Refer to the 'Wiring work' for the specification of grounding wire.
- When the grounding wire is too short, extend the grounding wire but bind the connection part with insulation tape. (Do not bury the connection).
- Secure the grounding wire in position with staples.



- When the grounding rod is installed in a place where many people pass by, you must fix it firmly.

4. Carefully check the installation, by measuring the grounding resistance with a ground resistance tester.

- If the resistance is above required level, drive the grounding rod deeper into the ground or increase the number of grounding rods.

5. Connect the grounding wire to the electrical component box inside of the outdoor unit.

Setting indoor unit option switch and key function

PBA shape

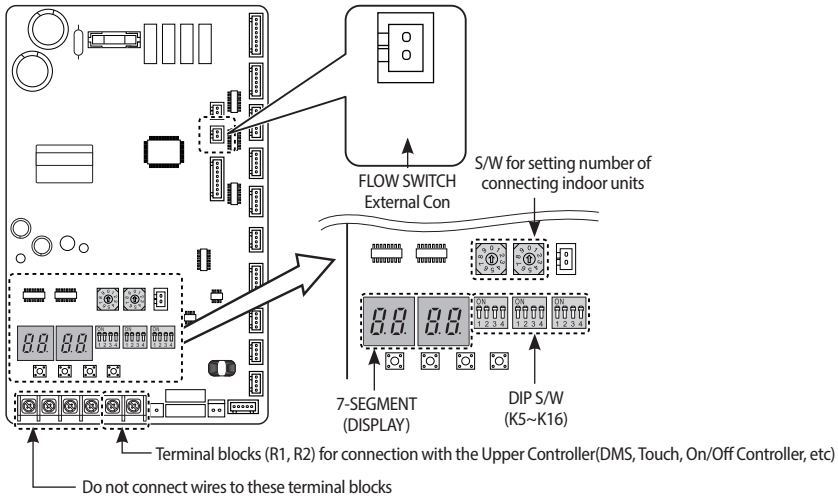

Setting indoor unit option switch and key function

Setting the number of connecting indoor units

Ex : When you connect 3 indoor units, set SW02 to 3

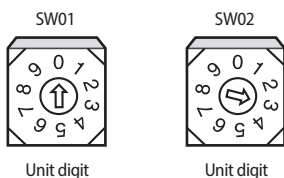

S/W function

Tact switch	Heating KEY operation	Cooling KEY operation	Reset	View Mode
	K1	K2	K3	K4
DIP switch	Manual silent option	Snow prevention	Cooling target evaporating temperature	Cooling target evaporating temperature
	K5	K6	K7	K8
	Silent mode	Silent mode	Heating capacity correction	Heating capacity correction
	K9	K10	K11	K12
	Total electric current option	Total electric current option	Defrost correction	Defrost correction
K13	K14	K15	K16	

DIP S/W specification setting

TACT switch	Number of presses	Content	SEG1	SEG2	SEG3	SEG4	Remark
K1	Press and hold 1 time	Check operation	8	8			
	1	Heating refrigerant charging	8	8			
	2	Heating trial operation	8	2			
	3	Heating pump out	8	3			
	4	Vacuum	8	4			
	5	Completion					
K2	1	Cooling refrigerant charging	8	5			
	2	Cooling trial operation	8	6			
	3	Cooling pump down	8	7			
	4	Checking the amount of refrigerant	8	8			
	5	Completion					
K3		Reset					

* If you perform Cooling refrigerant charging or Cooling pump down in high temperature environment, E407 (High pressure protection control) error or high pressure protection switch may operate.

► K4 input display order

(1) Current frequency → (2) Low pressure value → (3) Outdoor temperature → (4) Discharge temperature → (5) OLP temperature → (6) COND temperature → (7) Double pipe out tube temperature → (8) High pressure value → (9) FAN RPM → (10) ESC(EVI) EEV → (11) MAIN EEV → (12) Present running current → (13) Number of connected indoor units → (14) Number of operating indoor units → (15) Sum of indoor unit capacity → (16) Mode Master indoor address

Setting indoor unit option switch and key function

K4(Press and hold to enter the setting) -> K4 press(Number of press)	Displayed content	Display on segment		
0 time	Main Micom version	Version (ex. 0912)		
1 time	Inverter Micom version	Version (ex. 0912)		
2 times	EEPROM version	Version (ex. 0912)		
3 times	Automatically assigned address of the units	SEG1	SEG2	SEG3, 4
		Indoor unit: "A"	Indoor unit: "0"	Address (ex: 05)
4 times	Manually assigned address of the units	SEG1	SEG2	SEG3, 4
		Indoor unit: "A"	Indoor unit: "0"	Address (ex: 01)

► K5: Automatic / Manual Silent mode operation

Switch	Function (Silent mode operation control)
K5	
ON	Automatic Silent mode operation
OFF	Manual Silent mode operation

* You can use the Manual Silent mode operation, if you set the K5 DIP switch to 'OFF' and connect some external contact switch to the 'External Con' port of MAIN PBA (shown in p.37)

► K6: Snow prevention control option

Switch	Function (Snow prevention control)
K6	
ON	Disuse snow prevention control (Default)
OFF	Use snow prevention control

* When you set the snow prevention control as 'Use', outdoor fan will operate for one minute every 30minutes in the condition of Cooling/heating stop status at below 5°C.

► K7, K8: Changing cooling capacity correction table

Switch		Function (Target evaporating temperature)
K7	K8	
ON	ON	7 ~ 9 °C (Factory default setting)
ON	OFF	5 ~ 7 °C
OFF	ON	9 ~ 11 °C
OFF	OFF	10 ~ 12 °C

* Upgrade the performance by referring to the cooling long pipe performance data of the technical data book.

* If you upgrade the performance at your discretion, low discharge air temperature of an indoor unit might cause discomfort. This is the option for performance correction during long pipe installation only.

- K9, K10: Silent mode option. This reduces FAM RPM to operate the outdoor unit quietly during night operation.

Switch		Function (Silent mode)
K9	K10	
ON	ON	Disuse Silent mode
ON	OFF	STEP - 1
OFF	ON	STEP - 2
OFF	OFF	STEP - 3

- * Enables the silent mode for night-time in cooling mode. (It operates automatically depending on the temperature.)
- * However, if the external contact interface module (MIM-B14) is used, entering the silent mode is available with contact signal in cooling and heating mode.

- K11, K12: Changing heating capacity correction table

Switch		Function
K11	K12	
ON	ON	Default
ON	OFF	Default - 196 kPa
OFF	ON	Default - 98 kPa
OFF	OFF	Default + 98 kPa

- * Heating operation increases frequency when current high pressure is higher than target high pressure; vice versa, decreases frequency. When target high pressure is high, the discharge air temperature of an indoor unit will increase but energy consumption will increase as well.
- * Maintaining factory default status is recommended. However, if you want to reduce energy consumption or you are not satisfied with heating performance, control the operation according to the surrounding environment. As you decrease the target high pressure, energy consumption and noise may decrease but indoor air discharge temperature decreases as well.

- K13, K14: Changing current limit option table

Switch		Function		
K13	K14	4 HP	5 HP	6 HP
ON	ON	Default	Default	Default
ON	OFF	Default - 4(A)	Default - 2(A)	Default - 2(A)
OFF	ON	Default - 6(A)	Default - 4(A)	Default - 4(A)
OFF	OFF	Default - 8(A)	Default - 6(A)	Default - 6(A)

Classification		Model	Default
ø1	4HP	AM040*XMDEH	22A
		AM040*XMDEC	24A
	5HP	AM050*XMDEH	24A
		AM050*XMDEC	24A
ø3	6HP	AM060*XMDEH	32A
	4HP	AM040*XMDGH	10A
		5HP	AM050*XMDGH
	6HP	AM060*XMDGH	12A

Setting indoor unit option switch and key function

▶ K15, K16: Defrost Option → This is to control entering condition of defrost mode

Switch		Function
K15	K16	
ON	ON	MID
ON	OFF	LOW1
OFF	OFF	LOW2

- * Defrost mode will start when the temperature difference between outdoor and outdoor heat exchanger has become more than certain standard.
- * Factory default status is MID. When the function changes to LOW with option control, defrost entering temperature decreases. When defrost entering temperature decreases, the operation hour will be long but this means that the operation hour with the reduced heating capacity increases. This option is used at places where humidity is high and the defrost mode enters too frequently.
- * Maintaining factory default status is recommended.

Setting the option

1. Press and hold K2 to enter the option setting. (Only available when the operation is stopped)
 - If you enter the option setting, display will show the following. (If you have set the 'Emergency operation for compressor malfunction', 1 or 2 will be displayed on Seg 4.)

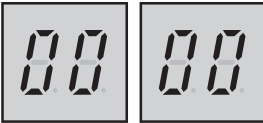

- Seg 1 and Seg 2 will display the number for selected option.
 - Seg 3 and Seg 4 will display the number for set value of the selected option.
2. If you have entered option setting, you can shortly press the K1 switch to adjust the value of the Seg 1, Seg 2 and select the desired option. (Refer to pages 45~47 for the Seg number of the function for each option)

Example)

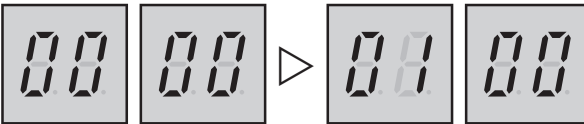

3. If you have selected desired option, you can shortly press the K2 switch to adjust the value of the Seg 3, Seg 4 and change the function for the selected option. (Refer to pages 45~47 for the Seg number of the function for each option)

Example)

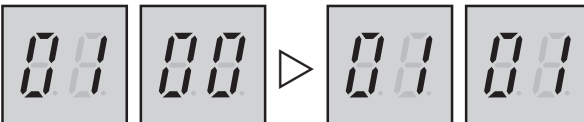

4. After selecting the function for options, press and hold the K2 switch for 2 seconds. Edited value of the option will be saved when entire segments blinks and tracking mode begins.



• Edited option will not be saved if you do not end the option setting as explained in above instruction.

- * While you are setting the option, you may press and hold the K1 button to reset the value to previous setting.
- * If you want to restore the setting to factory default, press and hold the K4 button while you are in the option setting mode.
 - If you press and hold the K4 button, setting will be restored to factory default but it doesn't mean that restored setting is saved. Press and hold the K2 button. When the segments shows that tracking mode is in progress, setting will be saved.

Optional item	Input unit	SEG1	SEG2	SEG3	SEG4	Function of the option	Remarks
Channel address	Main	0	0	A	U	Automatic setting (Factory default)	Address for classifying the product from upper level 0 ~ 15 controller (DMS, S-NET 3, etc.)
				0 ~ 15		Manual setting for channel (0 ~ 15)	

Inspection and check operation



Precautions before check operation

- When the outdoor temperature is low, turn on the main power 3 hours before beginning the operation.
 - If you start the operation immediately after turning on the main power, it may cause serious damage to the part within the product.
- Do not touch the refrigerant pipe during or right after the operation.
 - Refrigerant pipe may be hot or cold during or right after the operation depending on the status of the refrigerant which flows through the refrigerant pipe, compressor and other parts of the refrigerant cycle. If you touch the refrigerant during or right after the operation, you may get burns or frostbite.
- Do not operate the product with its panel or protection nets off.
 - There is risk of personal injury from the parts that rotates, heated or with the high voltage.
- Do not turn off the main power immediately after stopping the operation.
 - Wait for at least 5 minutes before turning off the main power. If not, water leakage or other problems may occur.
- Connect all the indoor units and the power supply for the outdoor unit and run auto or manual address setting. Run auto or manual address setting after changing the indoor unit PCB.

Inspection and check operation

Inspection before check operation

1. Check the power cable and communication cable of the indoor and outdoor unit.
2. Supply power to the outdoor unit 3 hours before check operation to pre-heat the crank case heater.
3. Before supplying the power, use a voltmeter and phase tester to check the voltage and the phase.
 - R,S,T terminal: check the 380 V ~ 415 V between wires (R-S, S-T, T-R) / 220V~240V between wires (L-N).
4. When the power is supplied, outdoor unit will execute tracking to check the indoor unit connection and other options.
5. Write down the installation report on the service history report paper attached on the front part of the control box.



- Supply power to the outdoor unit 3 hours before check operation to pre-heat the crank case heater.

6. Guaranteed range of check operation

For correct judgment, you must perform check operation in below indoor/outdoor temperature condition.

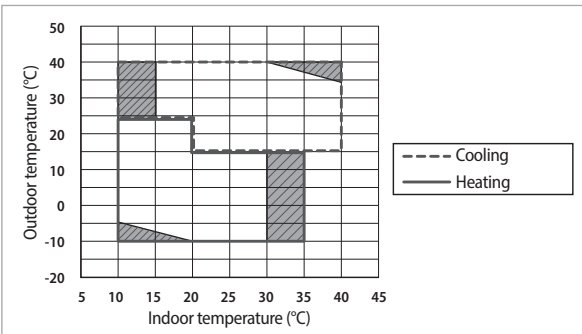

- Check operation selects and operates cooling/heating mode automatically.
- In the temperature range marked with slashed pattern, system protection control may trigger during operation. (It may be hard to judge the check operation correctly due to protection control operation.)
- When the temperature is outside of guaranteed range, accuracy of judgment on check operation may decrease near boarder line area.

Check operation

1. Use KEY MODE to run check operation.
 - When the check operation is not completed, UP (unprepared) will appear on the LED after the communication check and restrict compressor from operating. (UP Mode will be cleared automatically when check operation is completed.)
 - Check operation may proceed from 30 minutes maximum 50 minutes depending on the operation status.
 - During check operation, noise can be generated due to valve inspection. (Check the product if abnormal noise occurs continuously)
2. When error occurs during check operation, check the error code and take appropriate measures.
 - Refer to service manual if you need inspection or when other errors occur.
3. When check operation ends, use S-NET pro or S-CHECKER to issue a result report.
 - Refer to service manual for further actions if you have any items with "inspection required" sign on the result report.
 - After taking appropriate measure for the items with "inspection needed" sign, run the check operation again.
4. Check the following items by running (cooling/heating) trial operation.
 - Check if cooling/heating operation performs normally.
 - Individual indoor unit control: Check for air flow direction and fan speed.
 - Check for abnormal operation noise from the indoor and outdoor unit.
 - Check for proper draining from the indoor unit during cooling operation.
 - Use S-NET pro to check the detail operation status.
5. Explain to the user how to use the air conditioner according to the user's manual.
6. Hand over the installation manual to the customer so they can keep it with them.

Automatic refrigerant amount detection function (Checking th amount of refrigerant)

Charging refrigerant

- ▶ The R-410A refrigerant is blended refrigerant. Add only liquid refrigerant.
- ▶ Measure the quantity of the refrigerant according to the length of the liquid side pipe. Add quantity of the refrigerant using a scale.
- ▶ Open the manifold gauge valve connected to the liquid side service valve and add the liquid refrigerant.
- ▶ If you cannot add the whole quantity of the refrigerant while the outdoor unit is stopped, open the gas side and liquid side service valve. Then, add remaining refrigerant by pressing the refrigerant adding button of the outdoor PCB.

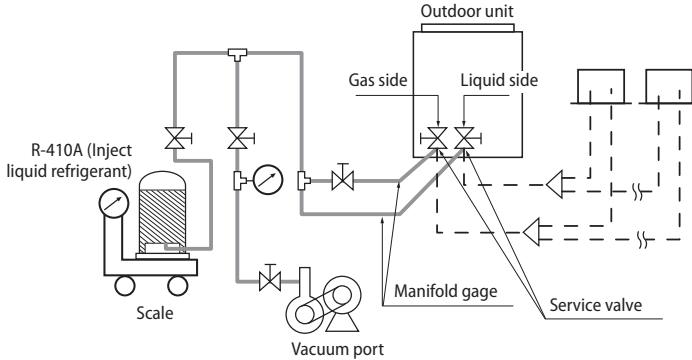

- Open the gas side and liquid side service valve completely after charging the refrigerant. (If you operate the air conditioner with the service valve closed, the important parts may be damaged.)
- Put on safety equipment when charging refrigerant.
- Do not charge the refrigerant when you adjust or control other product such as indoor units or EEV kits.
- When the ambient temperature is low in winter time, do not heat the refrigerant container to speed up the charging process. There is risk of explosion.
- Beware for possibility of refrigerant leakage when you connect the manifold gauge to the charging port for heating.
- Close the valve of the refrigerant container immediately after charging the refrigerant. If not, there might be a change in entire amount of refrigerant.

Pump Down

The object of pump down

- ▶ You can reduce as much refrigerant leakage as possible during product movement or repair by collecting the refrigerant to the outdoor unit.

Caution for pump down procedure

- ▶ The amount of refrigerant that can be put into an outdoor unit is limited due to the slim shape of the outdoor unit.
- ▶ Before performing pump down, most of the refrigerant should be put into an empty container at first. The maximum amount of refrigerant that can be put into the outdoor unit is 5kg.
- ▶ When the amount of system refrigerant exceeds the amount of maximum receptive capacity, compressor trip or damage by fire might be caused.

Pump down procedure

- ▶ Before performing pump down, collect the refrigerant into the empty container.
- ▶ Turn off the manifold gage.
- ▶ Turn off the service valve of liquid pipe side.
- ▶ Press K2 button on the outdoor unit PCB three times. ('H' is displayed on outdoor PCB LED.)
- ▶ When the compressor starts operating, observe low pressure using manifold gage.
- ▶ When the low pressure goes below $0\text{kg}/\text{cm}^2\text{g}$, turn off the service valve at gas side and finish the pump down operation. (To finish pump down operation, press K2 button one more time or press K3 button one time to be initiated.)



CAUTION

- When putting refrigerant into the refrigerant container, you must use the exclusive container that can be recharged. When remodeling normal refrigerant container illegally, explosion might occur.

Pump Down

How to put the refrigerant into the refrigerant container before pump down operation

- * When the amount of refrigerant charged in the system exceeds maximum receptive capacity, collect the refrigerant into the refrigerant container at first and then perform the pump down.
- ▶ Prepare the exclusive refrigerant container that can be recharged, scale, and manifold gage that can be recharged.
- ▶ Check the current amount of refrigerant within the system.
- ▶ After connecting the refrigerant container to an outdoor unit, operate 50% of all indoor units as cooling mode.
- ▶ Check the pressure of high pressure side for manifold gage after 10 minutes from cooling operation. When the pressure of high pressure side is above $30\text{kg}/\text{cm}^2, \text{g}$ decrease the number of operating indoor unit and make the pressure below $30\text{kg}/\text{cm}^2, \text{g}$.
- ▶ After checking that the pressure of high pressure side went below $30\text{kg}/\text{cm}^2, \text{g}$, open the manifold gage side valve(2) that is connected to the liquid pipe and refrigerant container valve. Then run the refrigerant from liquid pipe to refrigerant container.
- ▶ Check whether the proper amount of refrigerant are put into the container using a scale, turn off the valve and remove the manifold gage.
- ▶ The amount of refrigerant that can be put into the refrigerant container should be about 50% of all refrigerant of the whole system.
- ▶ Do not collect too much refrigerant in one refrigerant container.

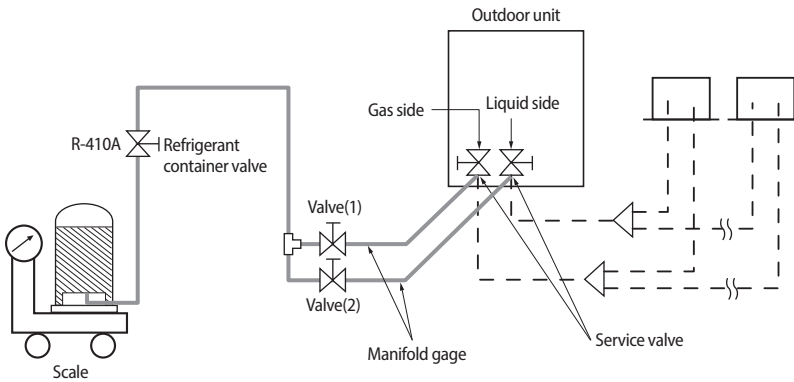

Checking lists after finishing installation

- ▶ Before supplying power, measure the power terminal (L, N) and outdoor unit grounding using insulation-resistance tester.
 - The measured value should be above 30MΩ.



- You must not measure the communication terminal since the communication circuit may get damaged.
- Check the short circuit using a circuit tester.

Installation	Outdoor unit	<ul style="list-style-type: none"> • Have you secured air discharge profile at the bottom of service cover? • Have you checked the external surface and the inside of the outdoor unit? • Is there any possibility of short circuit due to the heat of an outdoor unit? • Is the place well-ventilated and ensures space for service? • Is the outdoor unit fixed securely?
	Indoor unit	<ul style="list-style-type: none"> • Have you checked the external surface and the inside of the indoor unit? • Is the place well-ventilated and has enough space been allowed for service? • Have you checked if the center of the indoor unit is ensured and it is installed horizontally?
Refrigerant pipe work		<ul style="list-style-type: none"> • Have you selected correct pipes? • Are the liquid and gas valve open? • Is the total number of connecting indoor units within the allowable range? • Are the length and the height difference between the refrigerant pipes within the allowable range? • Is the refrigerant Y-joint properly installed? • Has the connection of liquid and gas pipes been correctly performed? • Have you chosen correct insulation for pipes and have you insulated them correctly? • Is the pipe or connection part properly insulated? • Is the quantity of the additional refrigerant correctly weighed in? (You must record the amount of additional refrigerant charging on the service record paper placed outside the outdoor unit.)
Installing the drain pipe		<ul style="list-style-type: none"> • Have you checked whether the drain pipes of the indoor unit and outdoor unit are connected together? • Have you completed the drain test? • Is the drain pipe properly insulated?
Wiring work		<ul style="list-style-type: none"> • Are the power cable and communication cable tightened firmly on the terminal board within the range of rated tightening torque? • Have you performed the earthing work 3 to the outdoor unit? • Is 2-core cable used for the communication cable? • Is the length of the wire is in the limited range? • Is the wiring route correct?
Setting ADDRESS		<ul style="list-style-type: none"> • Are the ADDRESSES of the indoor and outdoor units properly set? • Are the ADDRESSES of the remote controller properly set? (When using multiple remote controllers)
Option		<ul style="list-style-type: none"> • Have you checked whether the vibration-resistance frame is correctly installed if there is a possible vibration of the outdoor unit.

Trial operation

- ▶ Check the power supply between the outdoor unit and the cabinet panel.
 - 1 phase power supply : L, N
 - 3 phase power supply : R, S, T, N
- ▶ Check the indoor unit.
 - Check whether you have connected the power and communication cables correctly. (The communication cables between an indoor unit and outdoor unit are F1, F2.)
 - Check the thermistor sensor, drain pump/hose, and display are connected correctly.
- ▶ Check with Key mode or S-Net Pro.
 - At first, operate all the indoor units with Key mode and operate the indoor units individually with S-Net Pro.
 - In the beginning of operation, check the compressor operation sound. If there is a boom sound, stop the trial operation.
- ▶ Check the operation status of indoor and outdoor unit.
 - Check whether the cooling operation is done correctly.
 - Check the individual indoor unit control, wind velocity, and wind flow direction.
 - Check whether you can hear abnormal sound from indoor unit and outdoor unit.
 - Check whether the drainage is done correctly in cooling.
 - Check S-net Pro for detailed operation.
- ▶ Explain to the user the usage of the air conditioner by referring to the users manual.



CAUTION

- Turn on the outdoor unit 3 hours before the test operation to preheat the compressor.
- If the compressor is not preheated, 'CH' may appear on the outdoor unit PCB depending on the outdoor temperature.

Writing and keeping installation checking card

- ▶ Installation checking card is enclosed with the installation manual.
 - Installer should fill out the front side of the card meticulously.
 - Write basic information such as date of installation, name of an installer, contact information, supervision company etc.
 - Write additional information such as the name of outdoor unit models, unusual, calculation of the additional amount of refrigerant etc.
 - Write indoor unit related information such as indoor unit installation location, indoor unit model name etc.
- ▶ Keep the installation checking card in a designated place and do not lose it.

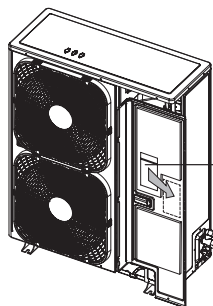

Installation checking card

SAMSUNG

This product is RoHS compliant